

*This is an author-created preprint version*

## Methodological aspects of spectrum occupancy evaluation in the context of cognitive radio<sup>†</sup>

Miguel López-Benítez\* and Fernando Casadevall

*Department of Signal Theory and Communications (TSC), Universitat Politècnica de Catalunya (UPC), Barcelona, Spain*

### SUMMARY

Cognitive radio has recently emerged as a promising solution to conciliate the existing conflicts between spectrum demand growth and spectrum underutilisation. The basic underlying idea is to allow unlicensed users to access in an opportunistic and non-interfering manner some licensed bands temporarily unoccupied by the licensed users. Within the framework of cognitive radio, several spectrum measurement campaigns have been performed in diverse locations and scenarios in order to assess the degree to which allocated spectrum bands are currently being used in real wireless communication systems. Although such measurement campaigns follow similar approaches, there is a lack of common and appropriate evaluation methodology, which would be desirable not only to prevent inaccurate results but also to enable the direct comparison of results from different sources. In this context, this work presents a comprehensive and in-depth discussion of several important methodological aspects that need to be accounted for when evaluating spectrum occupancy in the context of cognitive radio. Moreover, a quantitative evaluation of the impact of different factors on the obtained results along with various useful guidelines are also provided. The results presented in this work highlight the importance of carefully designing an appropriate methodology when evaluating spectrum occupancy in the context of cognitive radio. Copyright © 2010 AEIT

### 1. INTRODUCTION

Cognitive Radio (CR) has been identified as a promising solution to the so-called *spectrum scarcity problem*, which results from the steady spectrum demand growth and the actual spectrum underutilisation [1]. The basic underlying idea of the CR paradigm is to allow unlicensed users to access in an opportunistic and non-interfering manner some licensed bands temporarily unoccupied by the licensed users. CR is expected to dramatically increase the spectrum usage efficiency. However, before this paradigm

can turn into reality, a full understanding of the dynamic use of spectrum in real wireless communication systems is firstly required. To this end, spectrum measurements become an essential and unavoidable step.

The measurement of real network activities constitutes an important step towards a realistic understanding of dynamic spectrum use and hence towards the practical deployment of the future CR technology. One of the most important uses of spectrum measurements will be not only to convince regulatory bodies and policy makers on the necessity of new spectrum access policies but also to support them in taking actions to enhance the use of the currently underutilised spectral resources. The investments required in order to develop Dynamic Spectrum Access (DSA) technologies may be miss-applied if they do not address the current and future spectrum use situation. These investments and initiatives require a

\*Correspondence to: Miguel López-Benítez, Mobile Communication Research Group (GRCM), Department of Signal Theory and Communications (TSC), Universitat Politècnica de Catalunya (UPC), Campus Nord UPC, Building D4, Office 111, C/Jordi Girona 1-3, 08034 Barcelona, Spain. E-mail: miguel.lopez@tsc.upc.edu

<sup>†</sup>A previous version of this paper was presented in the 15th European Wireless Conference (EW 2009), Aalborg, Denmark.

quantitative support and a deeper understanding of the current and projected spectrum usage. Understanding the current use trends in the spectrum is required for the knowledgeable furtherance of these efforts. Therefore, spectrum measurements are critical to ensure that research investments target the evolving real-world technical issues.

From a technical point of view, spectrum measurements are also useful in detecting what bands are subject to low utilisation levels, thus assessing and characterising the availability of unoccupied spectral resources in terms of frequency, time, and space. This information can be very helpful to the research community in order to identify the most suitable and interesting bands for the future deployment of the CR technology. Besides this, the empirical data captured in spectrum measurements can find many other interesting practical applications. One example is the evaluation and validation of existing and novel DSA techniques with real-world data. Another application is the development of realistic spectrum usage models based on empirical data, which could be interesting not only for theoretical analyses of DSA techniques but also for the development of innovative and accurate simulation tools.

From the previous discussion it is clear that the practical development of the DSA/CR technology can significantly benefit from empirical measurements of the spectrum occupancy. The success of such enterprise, however, depends on the availability of reliable and accurate spectrum utilisation statistics. To the date, several spectrum measurement campaigns covering wide frequency ranges [2–20] as well as some specific licensed bands [21–25] have already been performed in diverse locations and scenarios in order to determine the degree to which allocated spectrum bands are used in real wireless communication systems. Tables 1 and 2 summarise the main technical aspects of various broadband spectrum measurement campaigns [2–20] (the meaning of some parameters will be clarified later on). Although previous spectrum measurement campaigns followed similar approaches, a detailed analysis of Tables 1 and 2 highlight the lack of a common and appropriate evaluation methodology. As pointed out in [26], different measurement strategies can result in widely divergent answers. Therefore, the availability of a common and reliable evaluation methodology would be desirable not only to prevent inaccurate results but also to enable the direct comparison of results from different sources. In this context, this work presents a comprehensive and in-depth discussion of several important methodological aspects that need to be carefully taken into account when evaluating spectrum occupancy. Certain issues discussed

in this work are rather intuitive but they have never been assessed in a formal, rigorous and quantitative manner in the context of CR. This paper presents various useful results that quantify the impact of different individual factors on the obtained occupancy statistics and reveal which of them require more attention. Such factors are grouped into aspects related to the design of the measurement setup (Section 2), the frequency (Section 3) and time (Section 4) dimensions<sup>†</sup> as well as the employed data post-processing procedures (Section 5). Based on such results, various useful and practical guidelines for future spectrum measurement campaigns are also provided. The main objective of this work is to cope with the major drawback of previous spectrum occupancy studies (i.e., the lack of a rigorous evaluation methodology) by providing a unifying methodological framework for future spectrum measurement campaigns. The results presented in this work highlight the importance of carefully following such an appropriate methodology when evaluating spectrum occupancy in the context of CR.

## 2. MEASUREMENT SETUP

Many factors need to be considered when defining a strategy to meet a particular spectrum measurement need. As detailed in [26], there are some basic dimensions that every spectrum measurement strategy should clearly specify: *frequency* (frequency span and frequency points to be measured), *location* (measurement site selection), *direction* (antenna pointing angle), *polarisation* (receiving antenna polarisation) and *time* (sampling rate and measurement period). The measurement setup employed in the evaluation of spectrum occupancy should be designed taking into account the previous factors since they play a key role in the accuracy of the obtained results. The measurement setup should be able to detect, over a wide range of frequencies, a large number of transmitters of the most diverse nature, from narrow- to wide-band systems and from weak signals received near the noise floor to strong signals that may overload the receiving system.

Depending on the purposes of the study, different configurations have been used in previous spectrum measurements ranging from simple setups with a single

<sup>†</sup>In the context of spectrum occupancy evaluation for CR, the spatial domain may refer to the impact of the selected measurement location on the occupancy statistics. The choice of the measurement location, however, can be regarded as an aspect more related to the particular evaluated scenario rather than the evaluation methodology itself. Therefore, the spatial domain is not treated as a methodological aspect in this work. A detailed analysis and discussion can be found in [27].

Table 1. Previous spectrum measurement campaigns – Part I: Measurement equipment.

Ref.	Frequency range (MHz)	Antennas	Filters	Pre-amplifiers
[2–5]	108–19700	108–960 MHz: Log-periodic mounted at a 45° angle. 960–19700 MHz: Slant polarised biconical and rotating parabolic reflector with dual horizontal/vertical feed.	Band-stop Band-pass	Yes
[6–8]	30–2900	30–960 MHz: Horizontal log-periodic and discone. 1240–2900 MHz: Horizontal log-periodic.	Band-stop Band/high-pass	Yes
[9–11]	30–2900	30–960 MHz: Discone. 960–2900 MHz: Log-periodic mounted at a 45° angle.	Band-stop Band/high-pass	Yes
[12, 13]	30–2900	30–1240 MHz: Discone. 1240–2900 MHz: Horizontal log-periodic.	Band-stop Band/high-pass	Yes
[14, 15]	30–3000	30–1000 MHz: Discone. 1000–3000 MHz: Discone.	Band-stop Band/high-pass	Yes
[16, 17]	400–7200	400–1200 MHz: Horizontal and vertical log-periodic. 1200–7200 MHz: Hor./vert. pyramidal log-periodic.	Band-pass	Yes
[18]	20–6000	20–1520 MHz: Discone. 1500–3000 MHz: Discone. 3000–6000 MHz: Radom discone.	No	Up to 3 GHz
[19]	806–2750	806–1000 MHz: Dipole. 1000–2750 MHz: Discone.	No	No
[20]	80–5850	80–5850 MHz: Vertical hybrid biconical/log-periodic.	No	No

Table 2. Previous spectrum measurement campaigns – Part II: Configuration parameters.

Ref.	Span (MHz) (No. of bands)	Frequency bin (kHz)	Resolution/video bandwidth (kHz)	Measurement period (hours)	Sweep time (secs)	Detection type	Decision threshold
[2–5]	6–2700 (38)	6–2700	3–3000/3–3000	0.09–11.51	0.02–12	Positive peak	N/A
[6–8]	9–214 (30)	18–427	10/10	1	0.1125–2.675	N/A	<i>m</i> -dB
[9]	9–280 (28)	18–559	3/3–10/10	22/30	0.1125–3.5	N/A	<i>m</i> -dB
[10]	9–280 (28)	18–559	10/10	9	0.1125–3.5	N/A	<i>m</i> -dB
[11]	9–280 (30)	18–559	10/10	0.233–312	0.1125–3.5	N/A	<i>m</i> -dB
[12, 13]	9–280 (30)	18–559	10/10	24	0.1125–3.5	N/A	<i>m</i> -dB
[14]	9–240 (31)	18–479	10/10	48	0.1125–3.0	N/A	<i>m</i> -dB
[15]	9–240 (31)	18–479	30/30	24	0.1125–3.0	N/A	<i>m</i> -dB
[16, 17]	6 (N/A)	10	10/10	24	0.150	Positive peak	Multi-dim.
[18]	1500 (4)	183	200/N/A	168	1	Average	PFA 1%
[19]	N/A (19)	N/A	15,120,250/N/A	0.33–0.5	≈ 5–10	Positive peak	5-dB
[20]	60 (N/A)	150	10/100	24	828	N/A	6-dB

antenna directly connected to a spectrum analyser [24] to more sophisticated and complex designs [5, 16]. Different configurations between both extreme points may determine various trade-offs between complexity and measurement capabilities. Our study is based on a spectrum analyser setup where different external devices have been added in

order to improve the detection capabilities of the system and hence obtain more accurate and reliable results (a simplified scheme is shown in Figure 1). The design is composed of two broadband discone-type antennas that cover the frequency range from 75 to 7075 MHz, a Single-Pole Double-Throw (SPDT) switch to select the desired

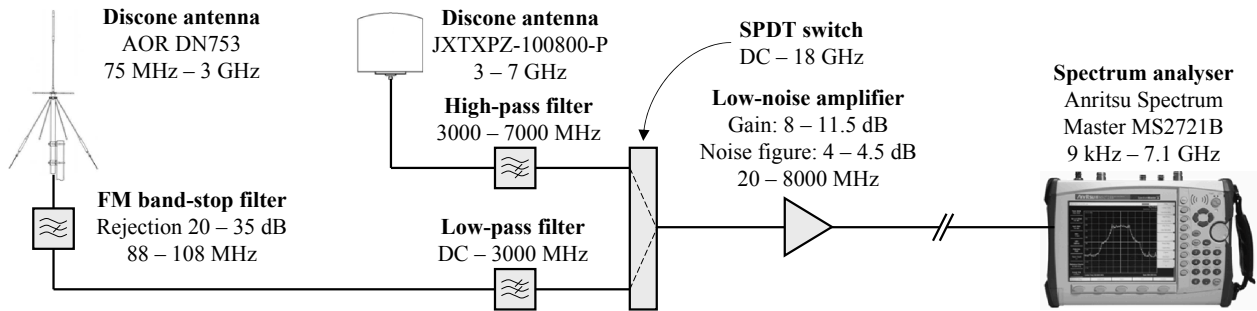

Figure 1. Measurement setup employed in this study.

antenna, several filters to remove undesired signals, a low-noise pre-amplifier to enhance the overall sensitivity and thus the ability to detect weak signals, and a high-performance spectrum analyser to record the spectral activity. These components are discussed in the following.

When covering small frequency ranges or specific licensed bands a single antenna may suffice. However, in broadband spectrum measurements from a few megahertz up to several gigahertz, two or more broadband antennas are required in order to cover the whole frequency range. Most of spectrum measurement campaigns have been based on omni-directional measurements in order to detect licensed signals coming from any directions. To this end, omni-directional vertically polarised antennas have been the most common choice. Our antenna system comprises two broadband discone-type antennas, which are wideband antennas with vertical polarisation and omni-directional receiving pattern in the horizontal plane. Even though some transmitters are horizontally polarised, they usually are high-power stations, such as e.g. TV stations, that can be detected even with vertically polarised antennas. The exceptionally wideband coverage (allowing a reduced number of antennas in broadband spectrum studies) and the omni-directional feature (allowing the detection of licensed signals coming from any directions) make discone antennas an attractive alternative in radio scanning and monitoring applications, and have been a preferred option for many past spectrum occupancy measurement studies.

In studies where the direction of the incoming signal needs to be resolved, it is possible to use multiple antenna arrays along with beam forming techniques in order to selectively receive or suppress (filter) signals in the angular domain. Directive antennas (e.g., log-periodic antennas) may also be used to this end as well as in order to improve the system's sensitivity at the cost of an increased complexity in the measurement procedures. For example,

if a directive antenna with  $\alpha$ -degree beamwidth is used in order to provide an additional  $G$ -dB gain with respect to an omni-directional antenna, it would be necessary to repeat the measurements  $N = \lceil 360/\alpha \rceil$  times in order to cover the entire 360-degree range of azimuths.

An alternative option to obtain additional gain is the use of amplification. Most spectrum analysers include built-in high-gain pre-amplifiers. Nevertheless, in some measurement conditions there may be high losses between the antenna port and the spectrum analyser. In this case a better option to improve the system's noise figure is to place a low-noise pre-amplifier right after the antenna system, as show in Figure 1. This amplifier will compensate for device and cable losses and increase the system's sensitivity. It is worth noting that choosing an amplifier with the highest possible gain not always is the best option in broadband spectrum surveys, where very different signal levels may be present. The existing trade-off between sensitivity and dynamic range must be taken into account. Thus, the correct pre-amplifier has to be chosen based on the specific measurement needs. If we wish absolutely the best sensitivity and are not concerned about measurement range, we would choose a high-gain, low-noise pre-amplifier. However, if we wish an improved sensitivity but cannot afford to give up any measurement range, a lower-gain pre-amplifier would be a more adequate choice. A reasonable design criterion when selecting the pre-amplifier is to guarantee that the different received signal strengths lie within the overall system's Spurious-Free Dynamic Range (SFDR), which is defined as the difference between a threshold or lower limit at which signals can be detected without excessive interference by noise (constrained by the system's noise floor) and the input signal level that produces spurs at levels equal to the noise power [28]. If the maximum input level is exceeded, some spurs might arise above the

system's noise floor and be detected as *signals* in truly unoccupied bands, thus resulting in inaccurate results and erroneous conclusions about the spectral occupancy. As shown in Figure 1, the use of band-stop filters to remove undesired overloading signals, such as those coming from FM audio broadcast stations, as well as low/high-pass filters to remove out-of-band components, which might create harmonics or intermodulation products, can be very helpful in satisfying the SFDR criterion without any loss in sensitivity at other frequencies.

Figures 2 and 3 quantitatively exemplify the impact of the overall system's sensitivity on the detected spectral activity. In each subfigure, the upper graph shows the Power Spectral Density (PSD) in average value (thick line) as well as minimum and maximum values. When considered together, average, minimum and maximum PSD provide a simple characterisation of the temporal behaviour of a channel. For example, if the results are quite similar, it suggests a single transmitter that is always on, experiences a low level of fading and is probably not moving. At the other extreme, a large difference among average, minimum and maximum PSD suggests a more intermittent use of the spectrum [24]. To more precisely quantify the detected spectral activity, the lower graph of each subfigure shows the duty cycle. For each measured frequency point, the duty cycle is computed as the fraction of PSD samples, out of all the captured PSD samples, indicating the presence of a licensed signal (a more formal definition is provided in appendix A). This metric represents the fraction of time a given frequency is occupied and, for the purposes of this work, it also serves as a metric quantifying the ability to detect the presence of a licensed signal within a certain frequency range.

Figure 2 shows the results obtained for the Global System for Mobile communications (GSM). As depicted in Figure 2(a), when the uplink direction is measured without any amplification (external pre-amplifier of Figure 1 or spectrum analyser's built-in amplifier), some signals are detected (see PSD) resulting in an overall duty cycle of 1.07% for the entire band. When only the external amplifier is connected, a higher number of licensed signals are detected and the resulting average duty cycle is 7.03% in this case, as shown in Figure 2(b). These results indicate that, when measuring the GSM uplink spectral activity at our measurement location, an absolute estimation error of nearly 6% was observed due to insufficient amplification. In the case of GSM downlink, poor sensitivity levels resulted in severe underestimation of spectral activity. While the results obtained without amplification in Figure 2(c) conclude that the GSM downlink band is subject to

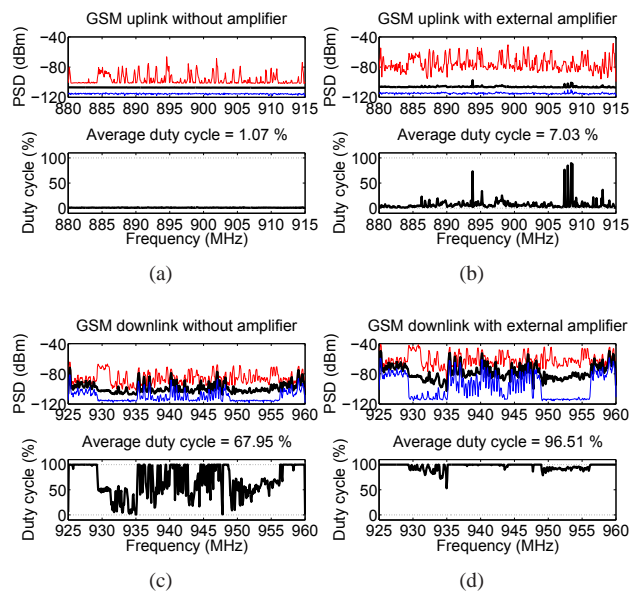

Figure 2. Impact of amplification on the activity detected for GSM: (a) uplink without amplifier, (b) uplink with external amplifier, (c) downlink without amplifier, and (d) downlink with external amplifier.

moderate/high usage levels (67.95%), the results obtained with amplification in Figure 2(d) reveal that such band is actually overcrowded with an average duty cycle of 96.51%, thus resulting in an absolute estimation error of  $96.51\% - 67.95\% = 28.56\%$ . These results highlight the importance of the sensitivity: if the measurement setup is not sensitive enough, the obtained occupancy statistics may be subject to high estimation errors, thus leading to wrong conclusions on the spectral activity and spectrum usage.

Figure 3 shows the results obtained for Broadband Wireless Access (BWA) systems operating in the 3.4–3.6 GHz band. Without amplification, Figure 3(a) shows that the band is detected as unoccupied (the average duty cycle of 0.72% is due to the criterion employed to select the decision threshold, which is explained in Section 5). By comparing the average duty cycle of Figures 3(b) and 3(c) it can be confirmed that the use of pre-amplifiers near the antenna system provides better sensitivity improvements than the use of the spectrum analyser's built-in amplifier. Although the external pre-amplifier's gain was only 8–11.5 dB, it enabled the detection of some signals that were not detected with the spectrum analyser's 25-dB gain built-in amplifier. However, Figure 3(d) demonstrates that both amplifiers are required in order to properly detect the presence of licensed systems operating in the measured

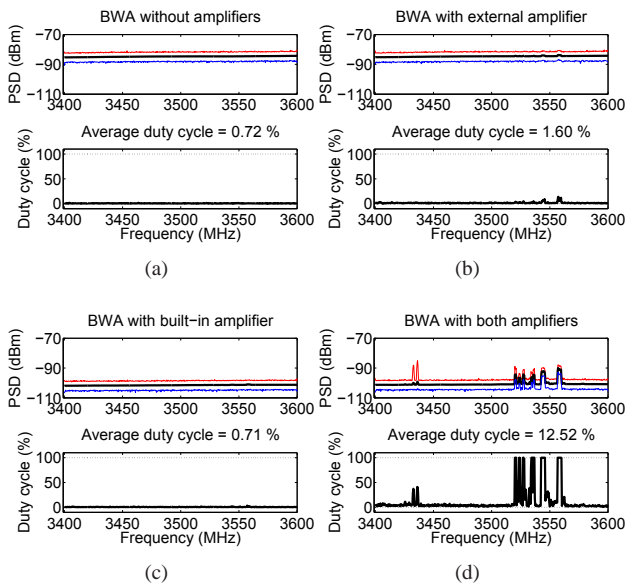

Figure 3. Impact of amplification on the activity detected for BWA: (a) without amplifiers, (b) with external amplifier, (c) with built-in amplifier, and (d) with both amplifiers.

band. These results indicate that amplification by itself is not enough: an appropriate amplification configuration is required in order to accurately estimate spectrum usage.

Other important aspect concerning the design of the measurement setup (frequently neglected in previous spectrum measurement campaigns) is the presence of interconnection accessories such as cables, connectors and adapters. Before performing any measurements, all the devices between the antenna output port and the spectrum analyser input port need to be calibrated such that the power loss/gain introduced by them is known over the entire frequency range. These values are needed in order to provide amplitude corrections for the measured PSD data.

Finally, the spectrum analyser constitutes the key element of the measurement setup. Since the different operating modes of spectrum analysers can significantly alter the results of a measurement, proper parameter selection is crucial to produce valid and meaningful results. Although the basic principles of spectral analysis [29] need to be taken into account, some particular aspects specific to CR have to be considered as well in order to obtain reliable and accurate results in the context of CR. Sections 3 and 4 discuss the proper selection of configuration parameters related to the frequency and time domains, respectively.

### 3. FREQUENCY DIMENSION

When the measurement equipment is designed, the next required step is to decide the frequency blocks (frequency spans) to be measured. This task basically consists in dividing the entire frequency range under study into smaller frequency blocks/spans over which measurements are performed individually. This is necessary, especially in broadband measurement campaigns, because measuring the whole frequency range under study as a single measurement block would result in an extremely poor frequency resolution and hence in a very coarse spectrum occupancy estimation. In previous spectrum measurement campaigns, the division into frequency blocks/spans has been performed according to arbitrary criteria and following a single-stage measurement procedure. However, when little is known about the spectrum bands to be measured and their spectral activity, a more reasonable approach is to follow a two-stage measurement procedure as performed in [30, 31]. In the first stage, the whole frequency range is divided into relatively large frequency blocks/spans, as in [30] (500 MHz) or in [18] (1500 MHz, see table 2). The measurement of such wide frequency blocks enables obtaining a first picture of spectrum occupancy very quickly since only a few frequency blocks need to be measured. This information may be useful to determine which spectrum bands are subject to higher activity levels and are therefore worthy of a more detailed study. Based on this first impression and following the local spectrum allocations, the entire frequency range can then be divided into smaller blocks/spans in such a way that higher frequency resolutions are obtained in those bands where some spectral activity is detected and/or the transmitted signals' bandwidth is narrower [31].

The relation between the transmitted signal's bandwidth and the frequency resolution is an important aspect to be accounted for that, unfortunately, has received little attention in previous spectrum measurement campaigns. For a given number of measured frequency points per block/span, the frequency bin size (i.e., the separation between two consecutively measured frequency points) increases with the frequency span. In general, higher frequency bins tend to result in higher spectrum occupancy rates, as it is shown in Figure 4 for the Digital Cellular System (DCS) and the Universal Mobile Telecommunications System (UMTS) downlink bands. However, the exact behaviour in both cases is different. In the case of DCS 1800, for frequency bins lower than the bandwidth of the transmitted DCS signal (200 kHz), the average duty cycles (45.16% and 58.91%) indicate that the

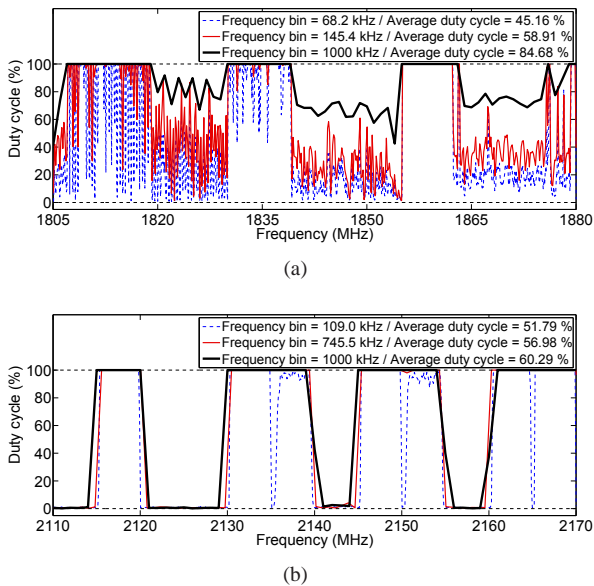

Figure 4. Impact of the frequency bin on the activity detected for: (a) DCS 1800 downlink, and (b) UMTS downlink.

band is subject to moderate usage levels. For a frequency bin of 1 MHz, which is quite greater than the signal bandwidth, the obtained duty cycle of 84.68% incorrectly concludes that the same band experiences a high level of utilisation. This phenomenon can be explained as follows. As it can be observed in Figure 4(a) for DCS 1800, some regions of the band are occupied during the entire measurement period. As a result, the three frequency bin values agree and provide similar duty cycles (nearly 100%) in such portions of the band. In other regions where the activity is lower, different frequency bin values provide very different results. Concretely, large frequency bin values tend to overestimate spectrum occupancy. For example, if a frequency bin of 1000 kHz is used, a single high-power 200 kHz active channel within the bin may result in the entire 1000 kHz bin being declared as occupied. As a result, frequency bin values larger than the signal bandwidth lead to important overestimations of spectrum occupancy in regions with moderate activity levels, which in turn results in greater average duty cycles for the entire band. In the case of UMTS the studied frequency bins are always lower than the signal bandwidth (5 MHz). Although the average duty cycle increases with the frequency bin, the difference is less significant (only 8.5% between 109 and 1000 kHz). This difference can indeed be ascribed to the fact that for the lower frequency bins some frequency points lie within the UMTS channels'

guard bands (as shown in Figure 4(b)), where the duty cycle is zero. Based on this discussion, it can be concluded that if the frequency bin is larger than the bandwidth of the signal being measured, spectrum occupancy is notably overestimated. On the other hand, occupancy estimation is reasonably accurate as long as the frequency bin size remains acceptably narrower than the signal bandwidth.

Another aspect related to the frequency dimension is the employed Resolution BandWidth (RBW). Narrowing the RBW increases the system's ability to resolve signals in frequency and decreases the noise floor, which in turn improves the ability to detect weak signals, at the cost of increased measurement times [29]. This trend is illustrated in Table 3. As it can be appreciated, decreasing the RBW results in higher average duty cycles for the same band (enhanced capability to detect the presence of licensed signals within the measured frequency range) as well as higher average sweep times (i.e., longer inter-sample intervals and therefore longer required measurement periods to obtain the same number of samples). The band considered in this example (146–235 MHz) comprises transmissions from radio technologies with various signal bandwidths, including Private Mobile Radio (PMR) networks (12.5/25 kHz), wireless microphones (200 kHz) and Digital Audio Broadcasting (DAB) systems (1.54 MHz). As a result, the occupancy statistics shown in Table 3 implicitly include the effects of several RBWs on different signal bandwidths. In the performed experiment, the 10-kHz RBW can be considered as an adequate trade-off between detection capability (represented by the average duty cycle) and measurement time (represented by the average sweep time). For the results shown in Table 3, the 10-kHz RBW configuration only misses the detection of 58.04% – 56.08%  $\approx$  2% of licensed signals with respect to the 3-kHz RBW configuration while it is able to capture 7.49s/2.81s = 2.67 times more PSD samples within the same measurement period. Wider RBWs result in shorter average sweep times but higher estimation errors, up to 17.68% for the 300-kHz RBW configuration. Moreover, since signal bandwidths of less than 10 kHz are unusual, a 10-kHz RBW can be considered as more than enough to resolve signals in frequency for most of the existing radio technologies. Based on these observations, a 10-kHz RBW can be considered as an appropriate choice for broadband spectrum surveys, offering an adequate trade-off between detection capability and required measurement time.

Table 3. Impact of the resolution bandwidth on the activity detected between 146 and 235 MHz.

RBW	Average duty cycle	Average sweep time
3 kHz	58.04%	7.49 s
10 kHz	56.08%	2.81 s
30 kHz	50.84%	1.85 s
100 kHz	43.30%	0.92 s
300 kHz	40.36%	0.79 s

#### 4. TIME DIMENSION

The time dimension of spectrum measurements is mainly defined by two parameters, namely the sampling rate, i.e. the rate at which PSD samples are captured, and the measurement period. While the former is constrained (and in some cases automatically adjusted) by the measurement device, the latter can be easily controlled.

Very different measurement periods have been considered in previous spectrum measurement campaigns, as it can be appreciated in the summary shown in Table 2. The selected measurement period depends on the trade-off between the overall time required to complete the measurement campaign and the particular objectives of the measurement study. Some previous studies have been aimed at identifying spectrum usage patterns over long periods and understanding any potential seasonality in the visible spectrum usage. For such kind of studies, long-term measurement campaigns with measurement periods of several years have been suggested [12, 32]. However, from the standpoint of resource utilisation, a short-term evaluation and characterisation of spectrum usage is frequently more interesting since in practice it has an important impact on the behaviour and performance of a DSA/CR network. In such a case, long-term measurements are not necessary. Although the employed measurement periods can be drastically shortened, a minimum number of PSD samples is required to correctly characterise the spectral activity of the measured bands. In this context, and from a statistical viewpoint, the question is how long should spectrum bands be measured in order to obtain a representative estimate of the actual spectrum usage in such bands. This section tries to answer this question by showing the effects of the measurement period on the obtained results in a quantitative manner. To this end, a portion of the DCS downlink band (1862.5–1875.5 MHz) was selected and measured during 24 hours. The average duty cycle for each measured frequency point was computed over 1-hour periods, thus obtaining the time

evolution of the duty cycle for different frequencies along one day. The obtained results are shown in Figures 5 and 6.

As it can be appreciated in Figure 5, the activity in the measured band was produced by at least two base stations, which can be inferred from the two broadcast channels that can clearly be identified at 1863.2 MHz and 1867.4 MHz for their constant duty cycles (the latter is lower than 100% because of the distance from the base station and the experienced fading loss). Traffic channels are also distinguishable in Figure 5 for their temporal variation.

In the particular case of broadcast channels, the spectral activity is constant and hence the *instantaneous* duty cycle matches the average value at every time instant. As a result, a 1-hour measurement period would report an acceptable estimate of the actual occupancy rate regardless of the start time. This conclusion is valid not only for broadcast channels of cellular mobile communication systems but in general for transmitters with a constant temporal activity pattern such as TV and FM broadcast stations, among many other types of wireless systems.

Although broadcast channels in Figure 5 show a constant activity pattern, the rest of the band exhibits an oscillating behaviour along time. When the entire band is considered, the *instantaneous* duty cycle then notably differs from the average value. For example, Figure 6 indicates that a 1-hour measurement period started at 9:32 would report an occupancy rate of 41.58% while the same time span started at 12:32 and 15:32 would report average duty cycles of 68.37% and 33.75%, respectively. None of these values is representative of the actual average usage of the band since the true mean over the 24-hour period was obtained to be 35.60%. Based on this discussion, a reasonable option to obtain representative results without any *a priori* information of the band to be measured is to consider measurement periods of at least 24 hours in order to account for potential daily temporal patterns.

Although a 24-hour measurement period can be regarded as adequate, it is certainly true that a relatively large number of recorded traces and thus reasonably long measurement periods are required to correctly characterise the spectral activity in allocated spectrum bands. For example, 48-hour periods would provide more realistic estimates. Moreover, 7-day periods would also include the potentially different usage patterns of some spectrum bands in weekdays and weekends. A 24-hour measurement period properly chosen can be considered as a reasonable trade-off between reliability of the obtained results and time required to complete the measurement campaign.



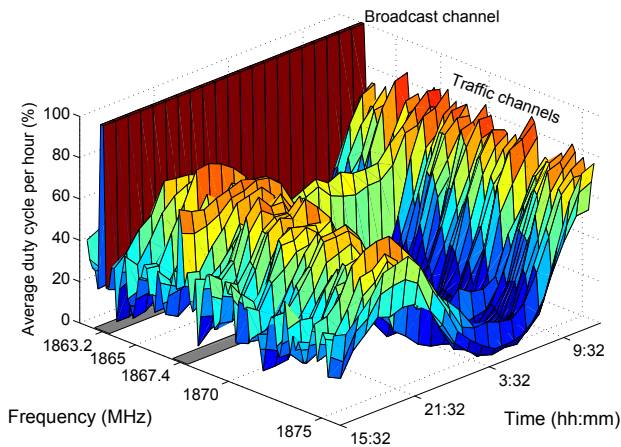

Figure 5. Average duty cycle per hour for DCS downlink.

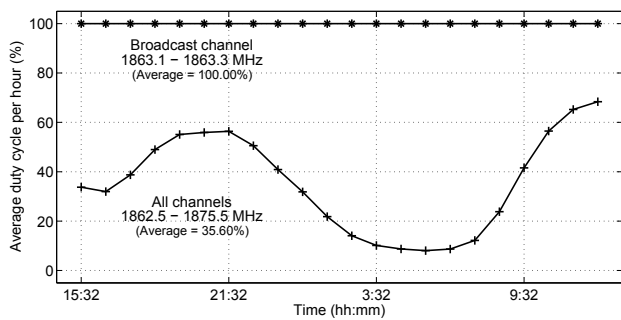

Figure 6. Average duty cycle per hour for DCS downlink.

**5. DATA POST-PROCESSING**

While the previous sections dealt with aspects to be considered before the measurement phase, this section discusses different methods for post-processing the empirical data captured during the measurement stage and the impact of such methods on the obtained statistic results. Regardless of the final measurement campaign’s objective (e.g., definition of adequate DSA policies, identification of sparsely used frequency bands or development of spectrum usage models), one of the very first steps of data post-processing is to determine which captured PSD samples correspond to occupied and unoccupied channels.

To detect whether a frequency band is used by a licensed user, different sensing methods have been proposed in the literature [33, 34]. They provide different trade-offs between required sensing time, complexity and detection capabilities. Depending on how much information is available about the signal used by the licensed network different performances can be reached. However, in the

most generic case no prior information is available. If only power measurements of the spectrum utilisation are available, the energy detection method is the only possibility left. Due to its simplicity and relevance to the processing of power measurements, energy detection has been a preferred approach for many past spectrum studies. Energy detection compares the received signal energy in a certain frequency band to a predefined decision threshold. If the signal lies above the threshold the band is declared to be occupied by the licensed system. Otherwise the band is supposed to be idle. Therefore, the measured PSD samples need to be compared to a threshold in order to determine whether they correspond to occupied channels or not.

The decision threshold is a critical parameter in data post-processing since its value severely impacts the obtained occupancy statistics. High decision thresholds may result in underestimation of the actual spectrum occupancy due to the misdetection of faded signals. On the other hand, excessively low decision thresholds may result in overestimation caused by noise samples above the threshold. As shown in Figure 7, different systems may exhibit different sensitivities to the variation of the decision threshold. In general, the duty cycle for high-powered transmitters such as TV stations and cellular communication base stations (downlink direction) shows a lower decreasing rate as the decision threshold increases. On the other hand, for bands where the received signal levels are lower the duty cycle is more sensitive to the decision threshold, with changes from 100% to 0% in 5 dB or less. This observation highlights the importance of using an adequate criterion to select the decision threshold.

Several methods to determine the decision threshold have been employed in previous studies. Most of them are based on *a priori* knowledge of noise properties. The simplest way to determine the decision threshold based on the noise knowledge is via empirical analysis, where the collected measurements are visually inspected and the threshold is arbitrarily placed somewhere in the middle between the noise and signal curves. For example, the threshold in [6–11] is decided based on visual inspection of PSD curves. An alternative approach is adopted in [25], where the spectral occupancy (average duty cycle) is computed as a function of the decision threshold for several used channels as in Figure 7, and the decision threshold is manually placed between the noise curve and the curves corresponding to the used channels. The main shortcomings of these approaches are their arguably lack of rigour, subjectivity and difficulty to be implemented in an automated fashion.

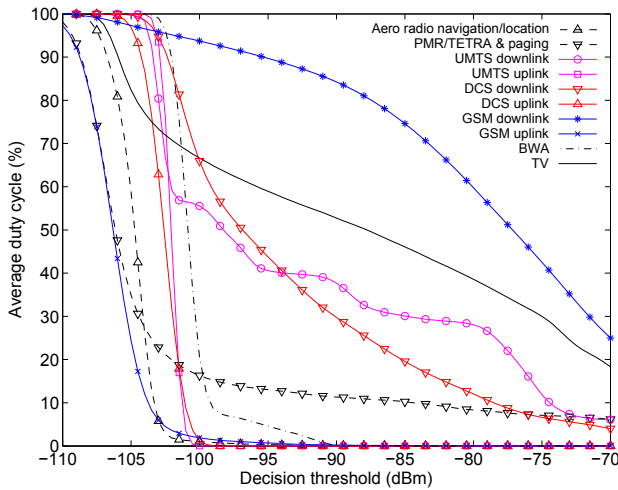

Figure 7. Average duty cycle as a function of the decision threshold for different systems: TV (470-862 MHz), BWA (3400-3600 MHz), GSM uplink (880-915 MHz) and downlink (925-960 MHz), DCS 1800 uplink (1710-1785 MHz) and downlink (1805-1880 MHz), UMTS uplink (1920-1980 MHz) and downlink (2110-2170 MHz), PMR/TETRA and paging (406.1-470 MHz), and aeronautical radio navigation and location (960-1350 MHz).

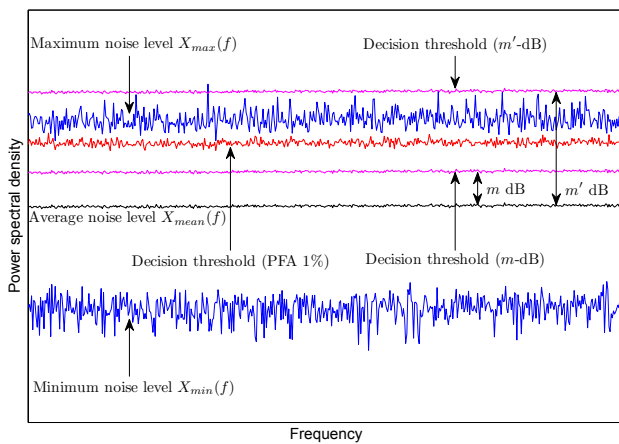

Figure 8. Various criteria to determine the decision threshold.

Other more rigorous methods to determine the decision threshold are shown in Figure 8. These methods assume a perfect knowledge of the noise properties, at least of the mean  $X_{mean}(f)$ , minimum  $X_{min}(f)$  and maximum  $X_{max}(f)$  values at different frequencies  $f$ , which can easily be measured by simply replacing the antenna with a matched load. A simple possibility to determine the decision threshold would be to select the maximum noise level  $X_{max}(f)$  recorded at each measured frequency point

$f$  as the decision threshold  $\gamma(f)$ :

$$\gamma(f) = X_{max}(f) \quad (1)$$

This method will be referred to as *MaxNoise criterion*. This option guarantees that no noise samples lie above the threshold and therefore that spectrum occupancy is never overestimated. However, occupancy may be underestimated due to weak signal samples lying below the maximum noise level. To solve this problem, an alternative option is to fix the decision threshold  $m$  decibels above the average noise level:

$$\gamma(f) = X_{mean}(f) + m \quad (2)$$

where  $m$  represents a constant quantity added to the mean noise level (e.g.,  $m = 6$  dB as in [20] or  $m = 10$  dB as suggested in [35]). This method will be referred to as *m-dB criterion*. The main drawback of this method is that the noise variance and also the maximum noise level  $X_{max}(f)$  may vary band-by-band depending on several configuration parameters such as the frequency span, which makes difficult to precisely control the relation between the noise level and the decision threshold. As illustrated in Figure 8, a fixed decision threshold may be appropriate for certain measurement conditions but may not be adequate if the measurement configuration changes from one band to another. Therefore, a constant  $m$ -dB threshold over the entire measurement range may not be appropriate. A different solution conciliating the previous methods is the *Probability of False Alarm (PFA) criterion*. In the context of CR, the PFA is defined as the probability that the CR network declares a channel to be occupied by a licensed signal when it is actually free. This event may be caused by strong noise samples along with low decision thresholds. Based on a target PFA for a CR network equal to  $P_{fa}$ , the decision threshold  $\gamma(f)$  at each measured frequency point  $f$  is fixed such that only a fraction  $P_{fa}$  of the noise samples  $X(f)$ , measured by replacing the antenna with a matched load, lie above the threshold:

$$\gamma(f) = F_{X(f)}^{-1}(1 - P_{fa}) \quad (3)$$

where  $F_{X(f)}^{-1}(\cdot)$  represents the inverse of  $F_{X(f)}(\cdot)$ , the cumulative distribution function of the noise values  $X(f)$ . It is worth noting that this alternative can be considered as an intermediate approach between the MaxNoise criterion, where spectrum occupancy is never overestimated, and the  $m$ -dB criterion, where spectrum occupancy may be significantly over/underestimated. The maximum overestimation error in which the PFA criterion

may incur is given by the value of  $P_{fa}$ , i.e. if the maximum fraction of noise samples allowed to lie above the decision threshold  $\gamma(f)$  is equal to  $P_{fa}$ , spectrum occupancy will never be overestimated by an amount greater than  $P_{fa}$ .

There exists a second category of algorithms to determine the decision threshold without any *a priori* knowledge of the noise properties. Some examples are the Otsu's algorithm [36] and the Recursive One-sided Hypothesis Testing (ROHT) algorithm proposed in [37]. The main drawback of these algorithms is that they are more complex and based on some assumptions that may not hold. Moreover, such assumptions are not necessary when noise properties can be known as it is our case. These methods are not considered in this study.

To quantitatively assess the impact of the decision threshold on the obtained occupancy statistics, the same set of empirical data was post-processed based on the energy detection principle but using the MaxNoise,  $m$ -dB and PFA criteria. The results obtained for various frequency bands are shown in Figure 9. Regarding the  $m$ -dB criterion, the performed experiments demonstrate, as previously mentioned, that a constant value of  $m$  fails to provide consistent results over the entire measurement range: while for some bands the obtained results are similar to those obtained with MaxNoise and PFA, for other bands the results are completely divergent. This indicates that the suitability of this criterion is highly questionable.

The rest of this section focuses on the comparison of MaxNoise and PFA. The comparison is performed based on the occupancy statistics obtained for four different types of bands, namely bands occupied by a wide diversity of licensed systems (146–235 MHz and 235–317 MHz), high-power transmitters (470–870 MHz and 915–960 MHz), low-power transmitters (870–915 MHz), and bands sparsely used (2700–3000 MHz) or completely unoccupied (5470–5875 MHz).

When the decision threshold is lowered from the MaxNoise criterion to the PFA 1% criterion, a maximum amount of 1% noise samples are allowed to lie above the decision threshold, which may be detected as signal samples. A maximum increase of 1% in the duty cycle due to noise samples is hence expected in this case. However, Figure 9 indicates that the average duty cycle for the 146–235 MHz and 235–317 MHz bands, which are occupied by a wide variety of licensed systems, increases 12.76% (from 43.32% to 56.08%) and 12.55% (from 28.90% to 41.45%), respectively, when moving from MaxNoise to PFA 1%. Since these increments are higher than 1% this clearly means that PFA is able to detect some additional weak signals around the noise level in these bands. If the decision

threshold is further lowered with the PFA 2%, 5% and 10% criteria, more weak signals are detected and the resulting average duty cycles increase (and so does the maximum overestimation error). A similar trend is observed for weak GSM uplink signals (870–915 MHz), although in this case the PFA improvement is less significant.

In the 2700–3000 MHz band (occupied only by a few military radars) and the 5470–5875 MHz band (completely unoccupied), the PFA criterion increases the average duty cycle by the same amount as the  $P_{fa}$  parameter of the algorithm. For example, when moving from PFA 2% to PFA 5% the duty cycle increases about 3%. The absence of licensed signals in these bands indicates that such increase is not caused by the detection of true weak signals but noise samples above the threshold. As shown in Figure 9, a similar behaviour is also observed for bands with high-power transmitters such as TV and GSM downlink. In this case, this means that in such bands lowering the decision threshold below the maximum noise level with the PFA criterion does not result in the detection of some additional weak signals, which indeed do not exist in these bands, but the misinterpretation of some noise samples as signals. In such a case PFA results in an occupancy overestimation equal to  $P_{fa}$  with respect to MaxNoise.

It can be concluded that, in general, PFA improves the detection performance of MaxNoise at the cost of a risk of incurring in overestimation errors in bands occupied by high-power transmitters. Increasing the target  $P_{fa}$  of the PFA method improves the detection performance but also the maximum overestimation error. Based on the obtained results, the PFA 1% criterion can be considered as a reasonable trade-off between improvement in the ability to detect weak signals and overestimation error in bands occupied by high-power transmitters.

## 6. CONCLUSIONS

Although several spectrum measurement campaigns have been performed in the context of cognitive radio, there is a lack of common and appropriate evaluation methodology, which would be desirable not only to prevent inaccurate results but also to enable the direct comparison of results from different sources. This work has presented a comprehensive and in-depth discussion of several important methodological aspects that need to be carefully taken into account when evaluating spectrum usage. A quantitative evaluation of the impact of different individual factors on the obtained results along with various useful guidelines have been provided as well. The results presented in this work highlight the importance of carefully

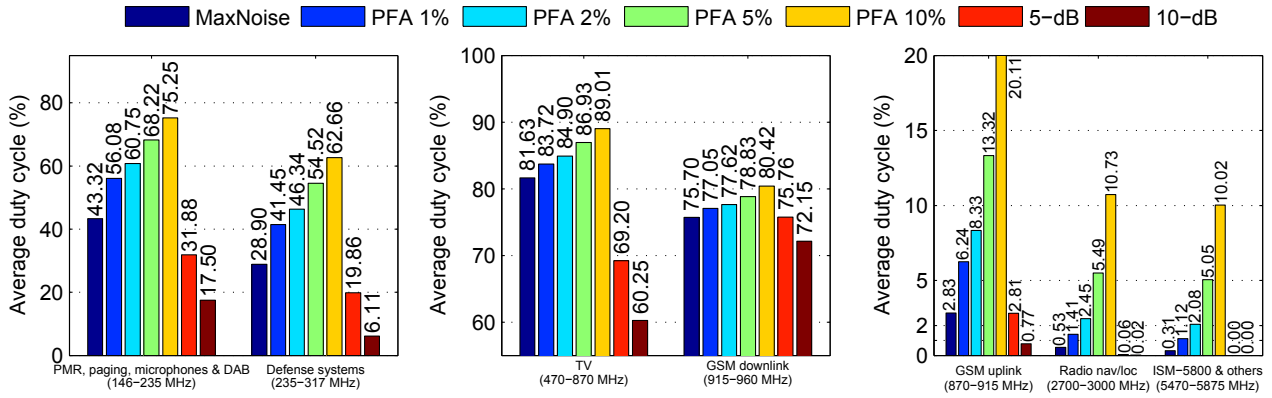

Figure 9. Impact of different decision threshold selection criteria on the detected activity for various licensed frequency bands.

designing an appropriate methodology when evaluating spectrum occupancy in the context of cognitive radio. This work has contributed a unifying methodological framework for future spectrum measurement campaigns.

### A. DUTY CYCLE DEFINITION

This appendix provides a formal definition for the duty cycle, which is used throughout this work as an evaluation metric quantifying the ability to detect the presence of a licensed signal within a certain frequency range.

The duty cycle is computed based on a finite set of discrete measurements collected along a range of frequencies  $F_{span} = F_{stop} - F_{start}$  (frequency span) and over a period of time  $T_{span} = T_{stop} - T_{start}$  (time span).

The measured discrete time instants  $t_i$  ( $T_{start} \leq t_i < T_{stop}$ ) are given by

$$t_i = T_{start} + (i - 1) \cdot T_r, \quad i = 1, 2, \dots, N_t \quad (4)$$

where  $T_r$  represents the time resolution and is given by the spectrum analyser's sweep time, which in turn depends on the selected configuration parameters. For a given time resolution  $T_r$ , the number of traces  $N_t$  collected within a time span  $T_{span}$  is given by  $N_t = T_{span}/T_r$ .

The measured discrete frequency points  $f_j$  ( $F_{start} \leq f_j < F_{stop}$ ) are given by

$$f_j = F_{start} + (j - 1) \cdot F_r, \quad j = 1, 2, \dots, N_f \quad (5)$$

where the frequency resolution  $F_r = F_{span}/N_f$  is given by the frequency bin, determined by the selected frequency span  $F_{span}$  and the number of frequency points  $N_f$  measured by the spectrum analyser.

The set of Power Spectral Density (PSD) samples collected by a spectrum analyser over a time span  $T_{span}$  and along a frequency span  $F_{span}$  can be represented by a  $N_t \times N_f$  matrix  $\mathbf{M}$  as

$$\mathbf{M} = [M(t_i, f_j)] \quad (6)$$

where each element  $M(t_i, f_j)$  represents the PSD sample captured at time instant  $t_i$  ( $i = 1, 2, \dots, N_t$ ) and frequency point  $f_j$  ( $j = 1, 2, \dots, N_f$ ).

To compute the duty cycle, the presence or absence of a licensed signal needs to be determined for each PSD sample  $M(t_i, f_j)$ . In other words, for each captured PSD sample it is necessary to determine whether the sample corresponds to a licensed signal sample or a noise sample. Several signal detection principles have been proposed in the literature to perform such task [33, 34]. However, as discussed in section 5, when only power measurements of the spectrum utilisation are available, the energy detection method is the only possibility left. Energy detection compares the received signal energy in a certain frequency band to a predefined threshold. If the signal energy lies above the threshold, a licensed signal is declared to be present. Otherwise, the measured frequency channel is supposed to be idle. Following this principle, a binary spectral occupancy matrix

$$\mathbf{\Omega} = [\Omega(t_i, f_j)] \quad (7)$$

is defined, where each element  $\Omega(t_i, f_j) \in \{0, 1\}$  is computed as

$$\Omega(t_i, f_j) = \xi(M(t_i, f_j), \gamma(f_j)) \quad (8)$$

with  $\gamma(f_j)$  being an energy decision threshold for frequency point  $f_j$  and  $\xi(x, y)$  a function defined as

$$\xi(x, y) = \begin{cases} 0, & x < y \\ 1, & x \geq y \end{cases} \quad (9)$$

Each element  $\Omega(t_i, f_j)$  in matrix  $\Omega$  represents the presence  $\Omega(t_i, f_j) = 1$  or absence  $\Omega(t_i, f_j) = 0$  of a licensed signal at time instant  $t_i$  and frequency point  $f_j$ , according to the energy detection principle based on an energy decision threshold  $\gamma(f_j)$ . Unless otherwise stated, the decision threshold is set according to the Probability of False Alarm 1% (PFA 1%) criterion (see section 5).

For each measured frequency point  $f_j$ , the duty cycle  $DC_{f_j}$  is computed as the proportion of PSD samples, out of all the PSD samples recorded at that frequency, that lie above the decision threshold  $\gamma(f_j)$  and hence that are considered as samples of occupied channels:

$$DC_{f_j} = \frac{1}{N_t} \sum_{i=1}^{N_t} \Omega(t_i, f_j) \quad (10)$$

For a frequency point  $f_j$ , this metric represents the fraction of time that the frequency is considered to be occupied. For a certain frequency span (i.e., range of frequencies  $j = 1, 2, \dots, N_f$ ), the average duty cycle  $DC$  of the band is computed by averaging the duty cycle  $DC_{f_j}$  of all the  $N_f$  frequency points measured within the band:

$$DC = \frac{1}{N_f} \sum_{j=1}^{N_f} DC_{f_j} = \frac{1}{N_t} \frac{1}{N_f} \sum_{i=1}^{N_t} \sum_{j=1}^{N_f} \Omega(t_i, f_j) \quad (11)$$

This metric represents the average degree of spectrum utilisation within certain time ( $T_{span}$ ) and frequency ( $F_{span}$ ) spans. The duty cycle is usually given in percentage and this is the convention adopted in this study.

The interest of using the duty cycle as the main evaluation metric in this work is as follows. The duty cycle, by definition, represents the proportion of PSD samples corresponding to occupied channels, i.e. samples where the presence of a licensed signal has been detected. Under the right assumptions and evaluation conditions, higher duty cycles can be related to a better capability to detect the presence of a licensed signal within a certain frequency range. Based on this principle, the signal detection capabilities of different measurement setups, configurations, methods or algorithms can be evaluated and compared in terms of the duty cycle, inferring better signal detection capabilities for those approaches providing

higher duty cycles. Moreover, the duty cycle constitutes a simple, intuitive and easily computable evaluation metric.

#### ACKNOWLEDGEMENTS

This work was supported by the Spanish Ministry of Science and Innovation (MICINN) under research project COGNOS (Ref. TEC2007-60985) and FPU grant AP2006-848.

#### REFERENCES

- [1] Akyildiz IF, Lee WY, Vuran MC, Mohanty S. A survey on spectrum management in cognitive radio networks. *IEEE Communications Magazine* Apr 2008; **46**(4):40–48.
- [2] Sanders FH, Lawrence VS. Broadband spectrum survey at Denver, Colorado. *Technical Report 95-321*, National Telecommunications and Information Administration (NTIA) Sep 1995.
- [3] Sanders FH, Ramsey BJ, Lawrence VS. Broadband spectrum survey at San Diego, California. *Technical Report 97-334*, National Telecommunications and Information Administration (NTIA) Dec 1996.
- [4] Sanders FH, Ramsey BJ, Lawrence VS. Broadband spectrum survey at Los Angeles, California. *Technical Report 97-336*, National Telecommunications and Information Administration (NTIA) May 1997.
- [5] Sanders FH. Broadband spectrum surveys in Denver, CO, San Diego, CA, and Los Angeles, CA: Methodology, analysis, and comparative results. *Proceedings of IEEE International Symposium on Electromagnetic Compatibility (EMC 1998)*, vol. 2, 1998; 988–993.
- [6] McHenry MA, Steadman K. Spectrum occupancy measurements, location 1 of 6: Riverbend Park, Great Falls, Virginia, April 7, 2004. *Technical Report*, Shared Spectrum Company Aug 2005. Available at: <http://www.sharedspectrum.com>.
- [7] McHenry MA, Steadman K. Spectrum occupancy measurements, location 2 of 6: Tyson's Square Center, Vienna, Virginia, April 9, 2004. *Technical Report*, Shared Spectrum Company Aug 2005. Available at: <http://www.sharedspectrum.com>.
- [8] McHenry MA, Chunduri S. Spectrum occupancy measurements, location 3 of 6: National Science Foundation building roof, April 16, 2004, revision 2. *Technical Report*, Shared Spectrum Company Aug 2005. Available at: <http://www.sharedspectrum.com>.
- [9] McHenry MA, McCloskey D, Lane-Roberts G. Spectrum occupancy measurements, location 4 of 6: Republican National Convention, New York City, New York, August 30, 2004 - September 3, 2004, revision 2. *Technical Report*, Shared Spectrum Company Aug 2005. Available at: <http://www.sharedspectrum.com>.
- [10] McHenry MA, Steadman K. Spectrum occupancy measurements, location 5 of 6: National Radio Astronomy Observatory (NRAO), Green Bank, West Virginia, October 10 - 11, 2004, revision 3. *Technical Report*, Shared Spectrum Company Aug 2005. Available at: <http://www.sharedspectrum.com>.

- [11] McHenry MA, McCloskey D, Bates J. Spectrum occupancy measurements, location 6 of 6: Shared Spectrum building roof, Vienna, Virginia, December 15-16, 2004. *Technical Report*, Shared Spectrum Company Aug 2005. Available at: <http://www.sharedspectrum.com>.
- [12] McHenry MA, Tenhula PA, McCloskey D, Roberson DA, Hood CS. Chicago spectrum occupancy measurements & analysis and a long-term studies proposal. *Proceedings of the First International Workshop on Technology and Policy for Accessing Spectrum (TAPAS 2006)*, 2006; 1–12.
- [13] McHenry MA, McCloskey D. Spectrum occupancy measurements: Chicago, Illinois, November 16-18, 2005. *Technical Report*, Shared Spectrum Company Dec 2005. Available at: <http://www.sharedspectrum.com>.
- [14] Erpek T, Steadman K, Jones D. Spectrum occupancy measurements: Dublin, Ireland, April 16-18, 2007. *Technical Report*, Shared Spectrum Company Nov 2007. Available at: <http://www.sharedspectrum.com>.
- [15] Erpek T, Lofquist M, Patton K. Spectrum occupancy measurements: Loring Commerce Centre, Limestone, Maine, September 18-20, 2007. *Technical Report*, Shared Spectrum Company Nov 2007. Available at: <http://www.sharedspectrum.com>.
- [16] Petrin A, Steffes PG. Analysis and comparison of spectrum measurements performed in urban and rural areas to determine the total amount of spectrum usage. *Proceedings of the International Symposium on Advanced Radio Technologies (ISART 2005)*, 2005; 9–12.
- [17] Petrin A. Maximizing the utility of radio spectrum: Broadband spectrum measurements and occupancy model for use by cognitive radio. PhD Thesis, School of Electrical and Computer Engineering, Georgia Institute of Technology Aug 2005.
- [18] Wellens M, Wu J, Mähönen P. Evaluation of spectrum occupancy in indoor and outdoor scenario in the context of cognitive radio. *Proceedings of the Second International Conference on Cognitive Radio Oriented Wireless Networks and Communications (CrownCom 2007)*, 2007; 1–8.
- [19] Chiang RIC, Rowe GB, Sowerby KW. A quantitative analysis of spectral occupancy measurements for cognitive radio. *Proceedings of the IEEE 65th Vehicular Technology Conference (VTC 2007 Spring)*, 2007; 3016–3020.
- [20] Islam MH, Koh CL, Oh SW, Qing X, Lai YY, Wang C, Liang YC, Toh BE, Chin F, Tan GL, et al.. Spectrum survey in Singapore: Occupancy measurements and analyses. *Proceedings of the 3rd International Conference on Cognitive Radio Oriented Wireless Networks and Communications (CrownCom 2008)*, 2008; 1–7.
- [21] Steffes PG, Petrin AJ. Study of spectrum usage and potential interference to passive remote sensing activities in the 4.5 cm and 21 cm bands. *Proceedings of the IEEE International Geoscience and Remote Sensing Symposium (IGARSS 2004)*, vol. 3, 2004; 1679–1682.
- [22] Do J, Akos DM, Enge PK. L and S bands spectrum survey in the San Francisco bay area. *Proceedings of the Position Location and Navigation Symposium (PLANS 2004)*, 2004; 566–572.
- [23] Biggs M, Henley A, Clarkson T. Occupancy analysis of the 2.4 GHz ISM band. *IEE Proceedings on Communications* Oct 2004; **151**(5):481–488.
- [24] Ellingson SW. Spectral occupancy at VHF: Implications for frequency-agile cognitive radios. *Proceedings of the IEEE 62nd Vehicular Technology Conference (VTC 2005 Fall)*, vol. 2, 2005; 1379–1382.
- [25] Jones SD, Jung E, Liu X, Merheb N, Wang JJ. Characterization of spectrum activities in the U.S. public safety band for opportunistic spectrum access. *Proceedings of the 2nd IEEE International Symposium on New Frontiers in Dynamic Spectrum Access Networks (DySPAN 2007)*, 2007; 137–146.
- [26] Matheson RJ. Strategies for spectrum usage measurements. *Proceedings of the IEEE International Symposium on Electromagnetic Compatibility (EMC 1988)*, 1988; 235–241.
- [27] López-Benítez M, Casadevall F. On the spectrum occupancy perception of cognitive radio terminals in realistic scenarios. *Proceedings of the 2nd International Workshop on Cognitive Information Processing (CIP 2010)*, 2010; 1–6.
- [28] Egan WF. *Practical RF system design*. Wiley-IEEE Press, 2003.
- [29] Agilent. *Application note 150: Spectrum analysis basics*. Available at: <http://www.agilent.com>.
- [30] López-Benítez M, Umbert A, Casadevall F. Evaluation of spectrum occupancy in Spain for cognitive radio applications. *Proceedings of the IEEE 69th Vehicular Technology Conference (VTC 2009 Spring)*, 2009; 1–5.
- [31] López-Benítez M, Casadevall F, Umbert A, Pérez-Romero J, Palicot J, Moy C, Hachemani R. Spectral occupation measurements and blind standard recognition sensor for cognitive radio networks. *Proceedings of the 4th International Conference on Cognitive Radio Oriented Wireless Networks and Communications (CrownCom 2009)*, 2009; 1–9.
- [32] Bacchus RB, Fertner AJ, Hood CS, Roberson DA. Long-term, wide-band spectral monitoring in support of dynamic spectrum access networks at the IIT spectrum observatory. *Proceedings of the 3rd IEEE Symposium on New Frontiers in Dynamic Spectrum Access Networks (DySPAN 2008)*, 2008; 1–10.
- [33] Yücek T, Arslan H. A survey of spectrum sensing algorithms for cognitive radio applications. *IEEE Communications Surveys and Tutorials* 2009; **11**(1):116–130.
- [34] Ariananda DD, Lakshmanan MK, Nikoogar H. A survey on spectrum sensing techniques for cognitive radio. *Proceedings of the Second International Workshop on Cognitive Radio and Advanced Spectrum Management (CogART 2009)*, 2009; 74–79.
- [35] Radiocommunications Bureau. *Handbook on spectrum monitoring*. International Telecommunication Union (ITU) 2002.
- [36] Otsu N. A threshold selection method from gray-level histograms. *IEEE Transactions on Systems, Man, and Cybernetics* Jan 1979; **9**(1):62–66.
- [37] Datla D, Wyglinski AM, Minden GJ. A spectrum surveying framework for dynamic spectrum access networks. *IEEE Transactions on Vehicular Technology* Oct 2009; **58**(8):4158–4168.

## AUTHORS' BIOGRAPHIES

**Miguel López-Benítez** ([www.lopezbenitez.es](http://www.lopezbenitez.es)) received a B.Sc. degree (2003) and a M.Sc. degree (2006) in Telecommunications Engineering, both with First-Class Honors, from Miguel Hernández University (UMH), Elche, Spain, and was the recipient of the 2003 and 2006 University Education National Awards, a distinction from the Spanish Ministry of Education and Science to the best national academic records. His M.Sc. thesis was awarded a national research prize from the France Telecom foundation in the context of the 5th Archimedes University Competition, the main young scientist contest in Spain organized by the Spanish Ministry of Education and Science. From February 2003 to July 2006 he actively participated in several Spanish national and regional research projects in what today is the Ubiquitous Wireless Communications Research Laboratory (Uwicore, [www.uwicore.umh.es](http://www.uwicore.umh.es)), UMH. Since September 2006 he is with the Mobile Communication Research Group (GRCM, [www.grcm.tsc.upc.edu](http://www.grcm.tsc.upc.edu)) at the Department of Signal Theory and Communications of the Technical University of Catalonia (UPC), Barcelona, Spain. He currently is pursuing a Ph.D. degree in Telecommunications Engineering at UPC with the support of a FPU grant from the Spanish Ministry of Education and Science, and collaborates as a teaching assistant. He has been or is actively involved in European-funded projects AROMA, NEWCOM++ and FARAMIR along with Spanish project COGNOS. His current research interests include the field of mobile radio communication systems, with a special emphasis on radio resource management, heterogeneous wireless systems, quality of service provisioning, spectrum modeling and opportunistic/dynamic spectrum access in cognitive radio networks.

**Fernando J. Casadevall** ([ferranc@tsc.upc.edu](mailto:ferranc@tsc.upc.edu)) received an Engineer of Telecommunication and Dr. Engineering degrees from the Technical University of Catalonia (UPC), Barcelona, Spain, in 1977 and 1983 respectively. In 1978 he joined UPC, where he was an Associate Professor from 1983 to 1991. He is currently Full Professor in the Signal Theory and Communications Department. After graduation he was concerned with equalization techniques for digital fibre optic systems. He has also been working in the field of digital communications with particular emphasis on digital radio and its performance under multipath propagation conditions. In the last fifteen years, he has mainly been concerned with the performance analysis and development of digital mobile radio systems. In particular, his research interests include cellular and personal communication systems, multipath transceiver design (including software radio techniques), mobility and radio resources management, and end-to-end QoS issues. During the last ten years he participated in more than thirty research projects funded by both public and private organizations. In particular, he actively participated in ten research projects founded by the European Commission, being the Project Manager of three of them: ARROWS, EVEREST and AROMA. (See [www.grcm.tsc.upc.edu](http://www.grcm.tsc.upc.edu) for details.) Prof. Casadevall has published around one hundred and fifty technical papers in both international conferences and magazines; most of them correspond to IEEE publications. He has also been a Technical Program Committee member of different international IEEE supported conferences, as well as a reviewer of several IEEE magazines. From October 1992 to January 1996 he was responsible for the Information Technology Area in the National Agency for Evaluation and Forecasting (Spanish Nation Research Council).